

Serie

SR

Solamente en orientaciones

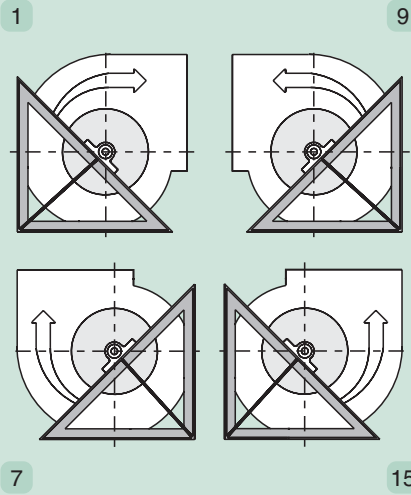
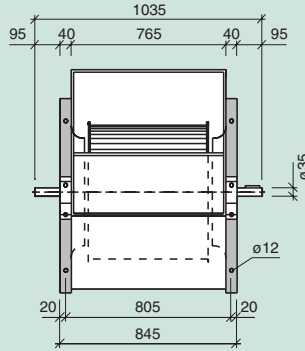
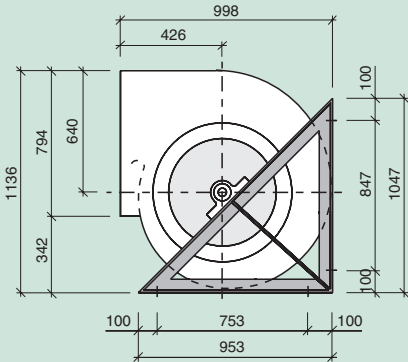

Serie

R

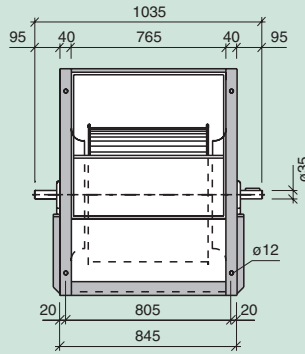
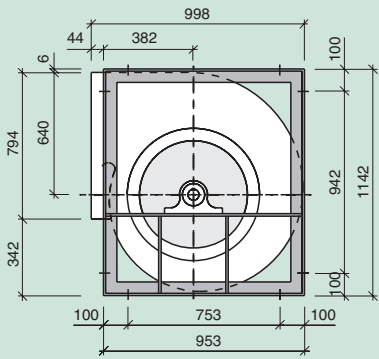

Serie

T2R

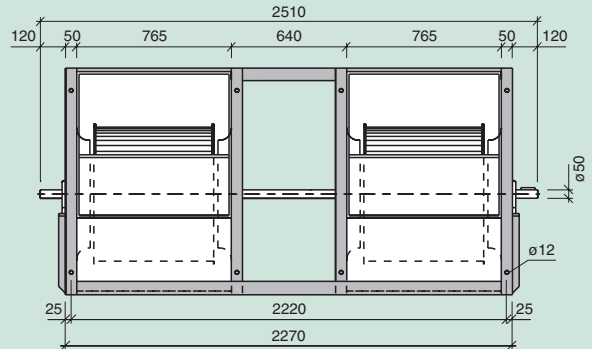
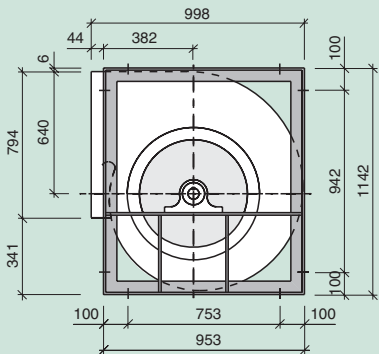

Serie - Series - Serie			SR	R			T2R	T3R
Límite de empleo. Operational limit. Limite d'emploi.	n max. motor max.	rpm kW	550 9	700 13			650 23	600 26
Velocidad tangencial. Tip speed. Vitesse tangentielle.	u	m/s	n (min ⁻¹) x 0.0351					
Momento de inercia. Moment of inertia. Moment d'inertie.	PD ² /4	Kg m ²	2.49	2.49			4.98	7.46
Peso del ventilador. Fan weight. Poids du ventilateur.		Kg	100	113			260	425
Coefficientes de corrección. Correction factors. Coefficients de correction.	V P _A n	m ³ /h kW min ⁻¹	x 1 x 1 x 1	x 1 x 1 x 1			x 2 x 2.15 x 1.05	x 3 x 3.25 x 1.08

