

Serie

SR

Solamente en orientaciones

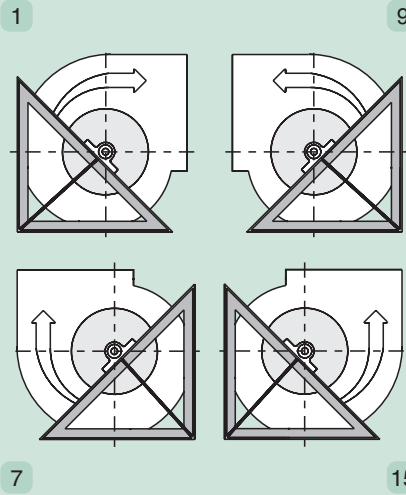
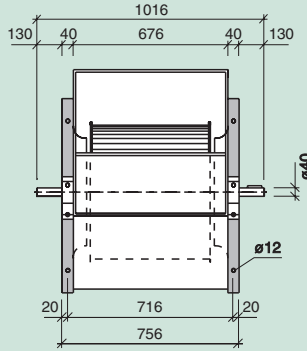
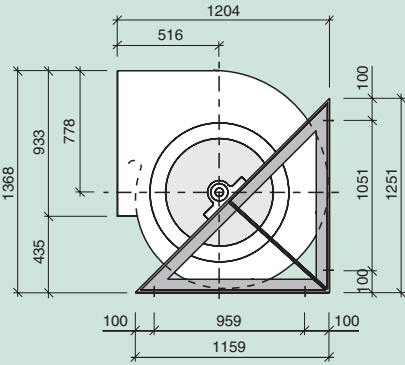

Serie

R

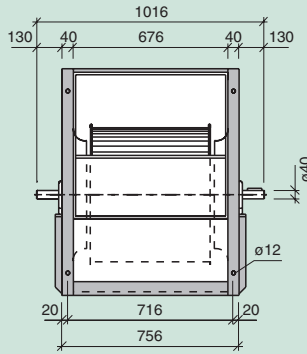
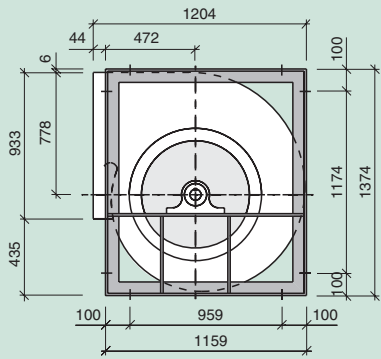

Serie

T2R

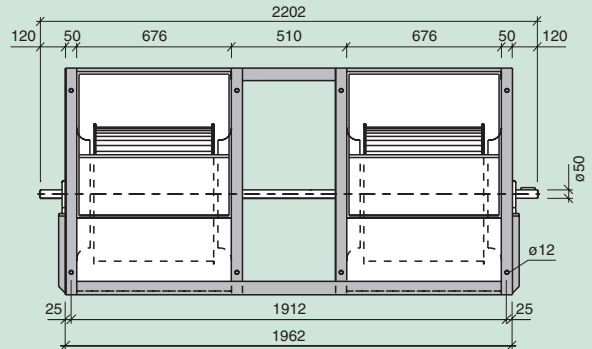
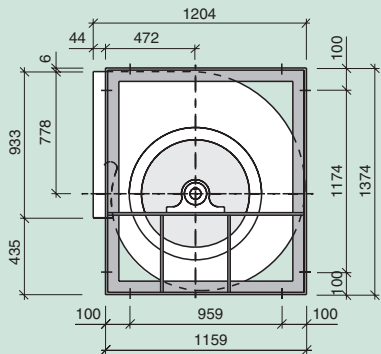

Serie - Series - Serie			SR	R		T2R	T3R
Límite de empleo. Operational limit. Limite d'emploi.	n max. motor max.	rpm kW	550 11	600 15		600 28	550 32
Velocidad tangencial. Tip speed. Vitesse tangentielle.	u	m/s	n (min ⁻¹) x 0.0419				
Momento de inercia. Moment of inertia. Moment d'inertie.	PD ² /4	Kg m ²	4.41	4.41		8.82	13.23
Peso del ventilador. Fan weight. Poids du ventilateur.		Kg	95	113		275	450
Coefficientes de corrección. Correction factors. Coefficients de correction.	V P _A n	m ³ /h kW min ⁻¹	x 1 x 1 x 1	x 1 x 1 x 1		x 2 x 2.15 x 1.05	x 3 x 3.25 x 1.08

